

Thermo Scientific Orion AQUAfast AQ4500 Turbidimeter

User Guide



ROSS and the COIL trade dress are trademarks of Thermo Fisher Scientific Inc. U.S. patent 6,793,787.

AQUAfast, Cahn, ionplus, KNIpHE, No Cal, ORION, perpHect, PerpHecT, PerpHecTion, pHISA, pHuture, Pure Water, Sage, Sensing the Future, SensorLink, ROSS, ROSS Ultra, Sure-Flow, Titrator PLUS and TURBO2 are registered trademarks of Thermo Fisher.

1-888-pHAX-ION, A+, All in One, Aplus, AQUAsnap, AssuredAccuracy, AUTO-BAR, AUTO-CAL, AUTO DISPENSER, Auto-ID, AUTO-LOG, AUTO-READ, AUTO-STIR, Auto-Test, BOD AutoEZ, Cable-Free, CERTI-CAL, CISA, DataCOLLECT, DataPLUS, digital LogR, DirectCal, DuraProbe, Environmental Product Authority, Extra Easy/Extra Value, FAST QC, GAP, GLPcal, GLPcheck, GLPdoc, ISEasy, KAP, LabConnect, LogR, Low Maintenance Triode, Minimum Stir Requirement, MSR, NISS, One-Touch, One-Touch Calibration, One-Touch Measurement, Optimum Results, Orion Star, Pentrode, pHuture MMS, pHuture Pentrode, pHuture Quatrode, pHuture Triode, Quatrode, QuiKcheK, rf link, ROSS Resolution, SAOB, SMART AVERAGING, Smart CheK, SMART STABILITY, Stacked, Star Navigator 21, Stat Face, The Enhanced Lab, ThermaSense, Triode, TRIUMpH, Unbreakable pH, Universal Access are trademarks of Thermo Fisher.

© 2009 Thermo Fisher Scientific Inc. All rights reserved. All trademarks are the property of Thermo Fisher Scientific Inc. and its subsidiaries.

The specifications, descriptions, drawings, ordering information and part numbers within this document are subject to change without notice.

This publication supersedes all previous publications on this subject.

Table of Contents

Chapter 1	Introduction	1
	Principle of Operation.....	2
	Display.....	3
	Keypad.....	4
Chapter 2	Meter Setup	5
	Battery Installation.....	5
	Vial Cover.....	6
	RS232 Connection.....	8
Chapter 3	Setup Menu	9
	Setup Functions.....	9
	Cal Chek.....	9
	Clock.....	10
	Set Baud.....	10
	Print.....	11
	Auto Print.....	11
	Digits.....	11
	Battery.....	12
	Self Test.....	12
Chapter 4	Calibration	13
	Preparing and Filling the Calibration Standard Vials.....	14
	Calibration Check.....	15
	Preparation of Low Turbidity Water.....	16
	Initial Calibration for EPA 180.1, ISO-NEPH or IR Ratio Modes...	17
	Daily Calibration Check for EPA 180.1, ISO-NEPH and IR Ratio Modes.....	18
	Calibration of ISO-ABSB Mode.....	18
	Calibration of White %T Mode.....	18
	Calibration of IR %T Mode.....	19
	Refilling the Calibration Standard Vials with Fresh Standard.....	19
	Preparation of Primary Calibration Standards.....	20

Chapter 5	Measurement	21
	Turbidity Sample Measurement	21
	Measurement of Low Level Turbidity Samples (< 1 NTU)	22
	Measurement Tips	23
	EPA Interim Approval Letter	24
Chapter 6	Functions	25
	Log Functions	25
	Average Functions	26
Chapter 7	Use with Printers and Computers	27
	Data Transmission Settings	27
Chapter 8	Customer Services	29
	Turbidimeter Self Test	29
	Turbidimeter Maintenance	29
	Vial Maintenance	29
	Operator Assistance Codes	30
	Assistance	30
	Warranty	30
	Declaration of Conformity	31
	Ordering Information	32
	Specifications	33
Appendix A	Tungsten vs. LED Discussion	35

Chapter 1 Introduction

The AQUAfast AQ4500 turbidimeter is the most advanced portable microprocessor based LED turbidimeter on the market today. The AQ4500 turbidimeter operates on the nephelometric and ratiometric principles of turbidity measurement. The AQ4500 turbidimeter allows turbidity measurement based on EPA 180.1 and ISO 7027 as well as an infrared ratio (IR ratio) mode that gives results in accordance with EPA GLI method 2. The AQ4500 also allows the user to make measurements based on percent transmittance (%T), American Society of Brewing Chemists (ASBC) units or European Brewing Chemists (EBC) units.

The AQUAfast AQ4500 turbidimeter is the only advanced completely waterproof turbidimeter with a rating of IP67. The AQ4500 can log 100 data points that can later be downloaded to a printer or computer.

The AQUAfast AQ4500 turbidimeter has received interim approval from the EPA for wastewater turbidity reporting when in the EPA180.1 mode and following Thermo Orion Method AQ 4500, Revision 5. See the **EPA Interim Approval Letter** section of this user guide and visit www.thermo.com/waterapps for updated information on EPA approval. Until final approval from the EPA for turbidity reporting, please contact your state or local regulatory agency for their requirements for interim approval methods. Refer to **Appendix A** for information on the benefits of a white LED light source for turbidity measurements.

Principle of Operation

Nephelometric turbidity is measured by determining the sideward-scattered light intensity. A light beam is passed through the flow cell and the scattered light produced by the solid particles (turbidity) is detected at a specific angle. This measurement method ignores the light that passes straight through the cell.

Figure 1
Pure Nephelometric
Turbidity
Measurement
without Color
Compensation

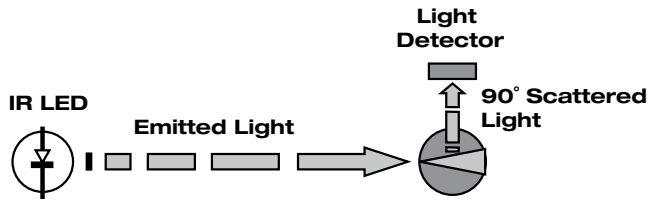

If the medium contains absorbent substances (such as colored constituents), these can easily attenuate the light beam by factors ranging from 2 to 10 and thus falsify the results. So it is absolutely necessary to eliminate the effect of the medium's absorption in such cases. This is achieved by using two light beams: a measurement beam and a reference beam. The turbidity is thus determined from their ratio.

Figure 2
Color Compensation
in the Dual-beam
System with Two
Photo Detectors

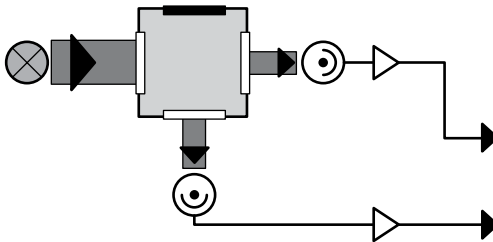

Display

Item	Number	Description
1	Calibrate	Icon lit while AQ4500 is in calibration mode
2	Setup	Icon lit while AQ4500 is in setup mode
3	Measure	Icon lit during measurement
4	Avg	Icon lit while AQ4500 performs zero
5	Units	Icons for units of measurement
6	?	Icon lit when AQ4500 prompts a question
7	Time	Icon lit while timer is active
8	Log	Icon lit if data is in AQ4500 log
9	Battery	Icon lit when battery in AQ4500 is low
10	Print	Icon lit during print function
11	188	Not used
12		Alphanumeric display
13		Numeric display

Figure 3
AQ4500 Display

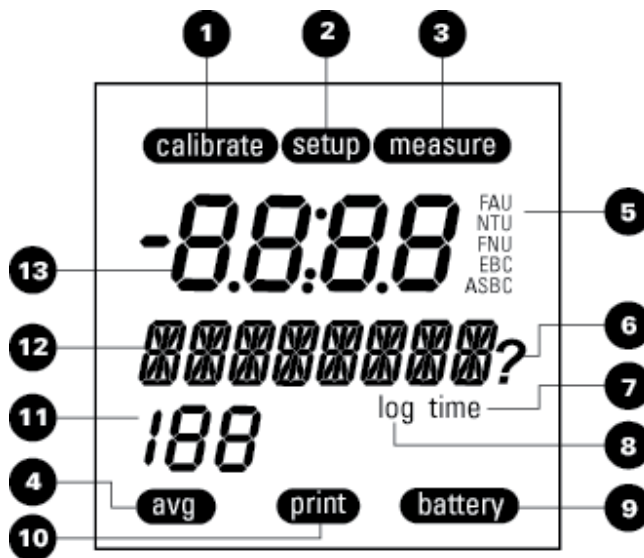

Keypad













Key	Description
	Turns the AQ4500 on or off
	Initiates print mode or inputs number 0
	Confirms an answer or inputs a decimal point
	Allows selection of measurement units or inputs number 1
	Initiates log mode or inputs number 2
	Scrolls down, answers “NO” or inputs number 3
	Initiates Average mode or inputs number 4
	Displays Time/Date and Stopwatch or inputs number 5
	Scroll ups, answers “NO” or inputs number 6
	Initiates Setup function or inputs number 7
	Initiates a calibration or inputs number 8
	Initiates a measurement or inputs number 9

Figure 4
AQ4500 Keypad



Chapter 2 Meter Setup

Battery Installation

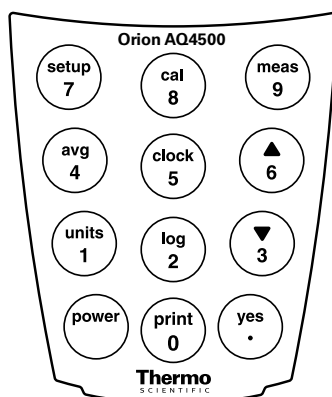
The AQ4500 turbidimeter requires 4 AA alkaline or lithium batteries. With 4 alkaline batteries, the expected life is 2,500 hours. With lithium batteries the expected life is 10,000 hours.

To install batteries, carefully loosen the two captive screws on the bottom of the battery cover. Remove the cover and insert batteries as shown in **Figure 5**.

Replace battery cover and tighten captive screws.

Figure 5
Battery Installation

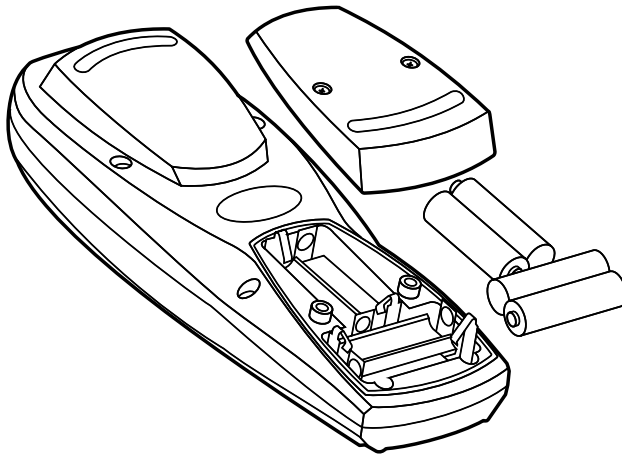

The AQ4500 has an auto-shutoff feature to conserve battery life. The auto-shutoff will turn the turbidimeter off if no keys have been pressed for approximately 20 minutes.

When the battery gets low “battery” will be displayed. Also at power-up an indication of battery life will be displayed.

Vial Cover

The vial cover serves two functions; first, it keeps the optical well covered so water, dirt and dust do not enter the well. Second, it covers the vial during measurement to prevent stray light from affecting the measurement. When the vial cover is installed and screwed down the AQ4500 is waterproof to IP67 standards.

The vial cover can be used in two ways. First for measurement when the waterproof integrity of the meter is important, place the vial cover over the vial and screw down as shown in **Figure 6**. To remove, unscrew and lift up.

Figure 6

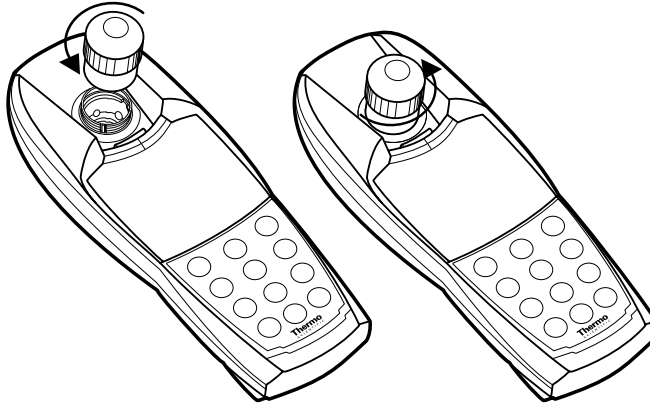

If using turbidimeter in a lab where waterproof integrity is not a factor, the cover can just be placed down over the vial. To remove vial cover, lift cover straight up as shown in **Figure 7**.

Figure 7

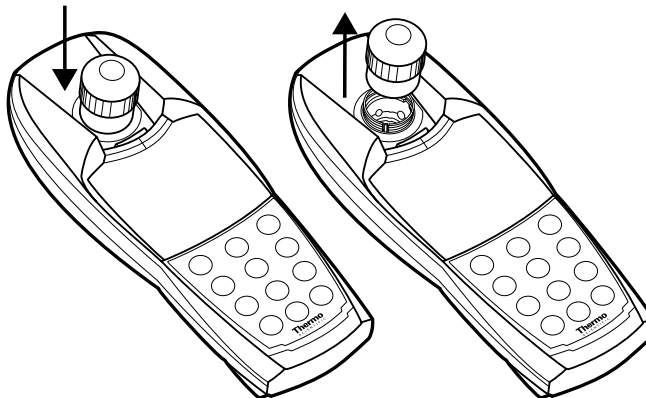

During measurement it is important to place the vial into the AQ4500 aligning the white triangle (▲) on the vial with the tab on the turbidimeter. See **Figure 8** aligning vial with tab on turbidimeter.

Figure 8

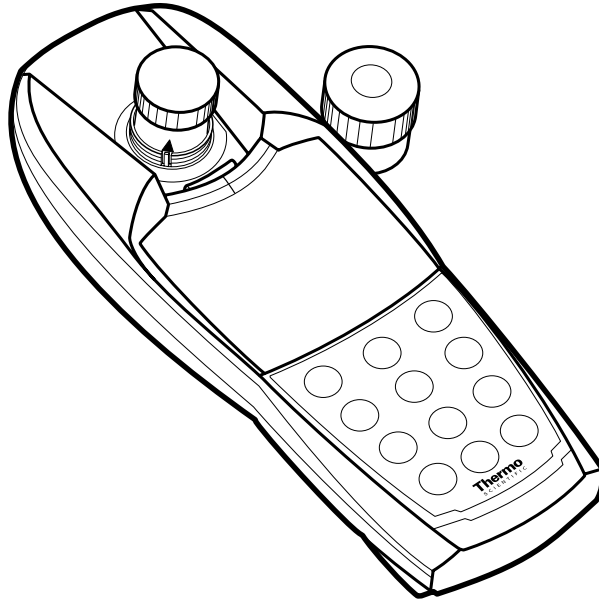

RS232 Connection

The AQ4500 has a bidirectional RS232 port located on the underside of the turbidimeter. See **Figure 9**. To connect the AQ4500 to a printer or computer, use the optional RS232 cable, Cat. No. AQ4CBL. See the **Use With Printers and Computers** section.

Figure 9
AQ4500 RS232
Cable Connection

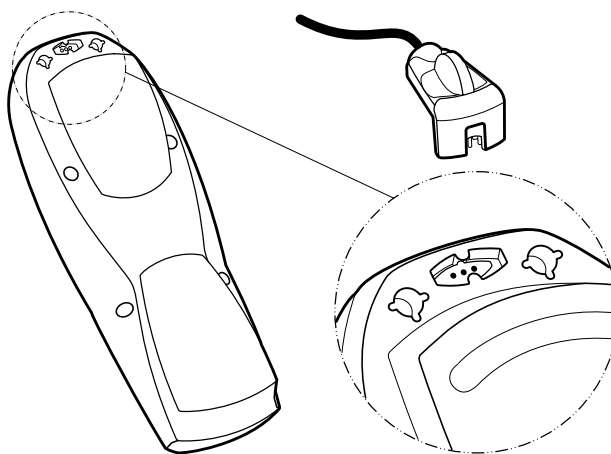

Chapter 3 Setup Menu

Setup Functions





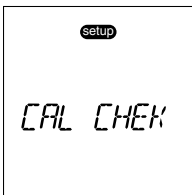

The **setup** key allows the user to access all the user selectable functions in the AQ4500 turbidimeter.

Cal Chek	Allows the user to confirm the time and date of the last calibration for the measurement mode selected.
Clock	Allows the user to set the date and time.
Set Baud	Allows the user to set the baud rate for the meter when using it with a printer or computer.
Print	Allows the user to set the print out format.
Auto Print	Allows the user to set the turbidimeter to automatically print each measurement.
Digits	Allows the user to select the number of significant digits to be displayed.
Battery	Allows the user to view remaining battery life.
Self test	Allows the user to initiate a self test to verify meter operation.

Cal Chek







Allows the user to confirm the last calibration for the selected measurement mode.

1. Press the  key.
2. Press the  or  key until “CAL CHEK” is displayed.
3. Press the  key to accept.
4. The last calibration date and time will be displayed.
5. Press the  or  key to return to the setup mode or press the  key to return to measurement mode.

Clock









Allows the user to set the time and date.

1. Press the  key.
2. Press the  or  key until “CLOCK” is displayed.
3. Press the  key to accept.
4. “20__” will be displayed. Enter the year.
5. “__ MONTH” will be displayed. Enter the month.
6. “__ DAY” will be displayed. Enter the day.
7. “__:__ (24) HOUR” will be displayed. Enter the time.
8. The AQ4500 will proceed to next setup mode.

Set Baud







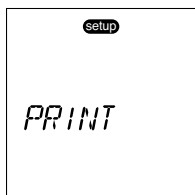

The default baud rate is 1200. The user may select a baud rate of 1200, 2400, 4800 or 9600.

1. Press the  key.
2. Press the  or  key until “SET BAUD” is displayed.
3. Press the  key to accept. 1200 or last baud rate selected will be displayed.
4. Press the  or  key until the desired baud rate is selected.
5. Press the  key to accept.

Print







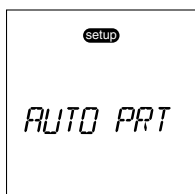

Allows the user to select the printout format. The user can select between a standard printout or a comma delimited format for importing data into a spreadsheet.

1. Press the  key.
2. Press the  or  key until “PRINT” is displayed.
3. Press the  key to accept. “STND PRN?” will be displayed.
4. Press the  or  key to toggle between “STND PRN?” and “CMA DELM?”.
5. Press the  key to accept.

Auto Print









Auto print “ON” will automatically send readings to the printer.

1. Press the  key.
2. Press the  or  key until “AUTO PRT” is displayed.
3. Press the  key to accept. “AUTO OFF?” or “AUTO ON?” will be displayed.
4. Press the  or  key to toggle between “AUTO OFF?” and “AUTO ON?”.
5. Press the  key to accept.

Digits







The digit selection allows the user to select the resolution of the reading, from 0.000, 0.00, 0.0 and 0 or auto resolution. Default is auto resolution.

1. Press the  key.
2. Press the  or  key until “DIGITS” is displayed.
3. Press the  key to accept.
4. Press the  or  key until the desired resolution is selected.
5. Press the  key to accept.

Battery



1. Press the  key.
2. Press the  or  key until “BATTERY” is displayed.
3. Press the  key to see remaining battery life.

Self Test

Puts the turbidimeter into a self-diagnostic mode. See the **Turbidimeter Self Test** section.



Chapter 4 Calibration

Warning: Never pour liquid directly into the sample chamber of the AQ4500 turbidimeter. Only use 24 mm diameter vials, Cat. No. AC2T24.

Note: Always use clean dry vials for calibration and measurement. See the **Measurement Tips** section.

The EPA approved SDVB primary standards in the meter kit are in plastic bottles for improved precision and shelf life. Five vials are included and labeled for each standard level.

The AQ4500 turbidimeter has been factory calibrated. Measure the provided SDVB primary turbidity standards, as if they are samples, before using the turbidimeter for the first time to verify the standards using the meter factory calibration. The standards should read within the accuracy specification for the standard, according to the certificate of analysis for that standard.

For best accuracy and regulatory compliance, perform an initial calibration with the SDVB turbidity standards after measuring them as samples and whenever a calibration check standard exceeds $\pm 10\%$ of the expected value. The EPA 180.1, ISO-NEPH, and IR Ratio modes may be calibrated in this manner. The EBC mode is automatically calibrated when the ISO-NEPH mode is calibrated. The ASBC mode is automatically calibrated when the EPA 180.1 mode is calibrated. The ISO-ABSB, White %T, and the IR %T modes require calibration with low-turbidity water only.

For EPA 180, ISO-NEPH, and IR Ratio modes, meter performance checks should be performed on a daily basis using the primary standards in the turbidity calibration kit, Cat. No. AC45ST, and low-turbidity water.

For ISO-ABSB, White %T, and the IR %T modes, the meter should be calibrated daily using low-turbidity water.

Preparing and Filling the Calibration Standard Vials

The five bottles of calibration standards supplied with your meter are more stable than Formazin, do not need to be shaken and have a shelf life of 12 months. If you use the supplied calibration standards to calibrate the instrument, review the expiration date (indicated on the bottle label) to ensure that the standards have not expired.

Note: It is important that the calibration standards are not violently shaken or agitated because air entrapment in the fluid introduces an error factor during calibration which subsequently will lead to an inaccurate measurement. Also, do not store in freezing temperatures which causes irreversible shrinkage of the standards' particles thus resulting to inaccurate calibration and measurement.

Before using the meter for the first time, rinse the inside of the vial with a small amount of the same NTU standard that will be used to fill that vial.

1. Gently pour about 5 mL of the standard into the vial.
2. Cap and swirl the vial so the inside of the vial is fully rinsed with the standard.
3. Pour the standard out of the vial.
4. Repeat steps 1 through 3.
5. Gently pour the standard into the vial up to the mark on the vial and cap the vial.
6. Repeat this rinse and filling procedure for the other three vials.

Note: The vial rinsing is most critical for precision with the lower NTU standards.

It is recommended to use the prepared calibration standard vials daily as check standards prior to the measurement of samples.

Calibration Check

1. Place the AQ4500 turbidity meter on a flat and level surface.
2. Insert the CAL 1 standard (0 NTU) into the sample chamber.
3. Press down the vial until it slides fully into the instrument. Cover the vial using the vial cover.
4. Select the measurement mode.
5. Press the  key.
6. The meter will display the results. Record the reading.
7. Repeat the calibration check for CAL 2, CAL 3, CAL 4 and CAL 5 calibration standards.
8. If the displayed results are within 10% of the nominal NTU value of the standard or the precision criteria required by your method, the calibration check passed and the meter is now ready for measurement.

Note: If a standard no longer reads within 10% of the nominal NTU value for the standard, the standard has most likely degraded. The lower level NTU standards will be less stable when stored in glass than the higher NTU standards. The lower level standards may need to be replaced periodically, especially if the value falls outside of the tolerance range. See the **Refilling the Calibration Standard Vials with Fresh Standard** section.

Table 1
Primary Calibration
Standards

EPA 180.1	ISO-NEPH	IR Ratio
1000 NTU	100 NTU	1000 NTU
100 NTU	10 NTU	100 NTU
10 NTU	1 NTU	10 NTU
1 NTU	Low-turbidity water	1 NTU
Low-turbidity water		Low-turbidity water

If desired, the meter may be calibrated at concentrations other than those listed in **Table 1**.

Note: Preparing standards and calibrating at these concentrations may yield reduced accuracy.







Table 2
Calibration Ranges

Cal	EPA 180.1	ISO-NEPH	IR Radio Standard Level
1	0.90 to 1.1 NTU	0.86 to 1.1 FNU	0.86 to 1.1 NTU
10	9.0 to 11 NTU	9.0 to 11.6 FNU	9.0 to 11.3 NTU
100	90 to 110 NTU	90 to 157 FNU	90 to 119 NTU
1000	900 to 1100 NTU	N/A	654 to 1100 NTU

Preparation of Low Turbidity Water

To obtain low-turbidity water for dilutions, nominal value 0.02 NTU, pass laboratory reagent-grade water through a 0.1 micron (mm) filter. Rinse the collecting flask at least twice with filtered water and discard the next 200 mL. Alternately, use laboratory reagent-grade water without filtering, if turbidity values are similar to or lower than filtered water. Use caution to avoid the introduction of dust and particulates.

Initial Calibration for EPA 180.1, ISO-NEPH or IR Ratio Modes

1. Select the measurement mode, EPA 180, ISO-NEPH or IR Ratio by scrolling up or down until the desired mode is displayed.
2. Press the  key. “H2O INSERT” will be displayed.
3. Insert vial containing pure water and press the  key.
4. “H2O WAIT” will be displayed and then “1.00 YES?”.
5. If the standard is 1.00, insert standard vial and press the  key. If standard is another value, press the  or  key, “CHANGE?” will be displayed. Press the  key. “STD VAL?” will be displayed. Enter value of standard using numeric keypad. Press the  key to accept.
6. Repeat step 5 for each standard.
7. When the calibration is complete the AQ4500 will proceed to the measure mode.

After performing the initial calibration with the primary calibration standards, perform a meter performance check by measuring the standards and a blank (turbidity-free water). The performance is good when the blank reads less than 0.1 NTU and the standards read within $\pm 10\%$ of the expected values. If results are not within limits, reanalyze the standards and blank. If the confirms that calibration is outside of limits, discontinue analysis and determine the cause of error.





Notes for Handling Cat. No. AC45ST Kit Standards

- Do not freeze kits
- Do not shake or agitate the sample
- Remove fingerprints and smudges with a soft wiper cloth

Daily Calibration Check for EPA 180.1, ISO-NEPH and IR Ratio Modes





Check meter performance daily by analyzing the SDVB primary standards and a blank before and after sample measurements. The performance is good when the blank reads less than 0.1 NTU and the standards read within $\pm 10\%$ of the expected values. If results are not within limits, pour fresh standards into the vials and reanalyze with the fresh SDVB primary standards and blank. If the reanalysis confirms that calibration is outside of limits, stop analysis and determine the cause of error before proceeding. A new initial calibration may be required.

Calibration of ISO-ABSB Mode

1. Select the measurement mode ISO-ABSB using the  or  key.
2. Press the  key. "H2O INSERT" will be displayed.
3. Insert vial containing turbidity-free water and press the  key. "H2O WAIT" will be displayed.
4. When the calibration is complete the AQ4500 will proceed to the measure mode.





After successful calibration, the low-turbidity water should read "0" FAU.

Calibration of White %T Mode

1. Select the measurement mode White %T using the  or  key.
2. Press the  key. "W→100?" will be displayed.
3. Insert vial containing low-turbidity water and press the  key.
4. "WAIT" will be displayed.
5. When the calibration is complete the AQ4500 will proceed to the measure mode.

After successful calibration, the low-turbidity water should read "CAL DONE".

Calibration of IR %T Mode

1. Select the measurement mode IR %T using the  or  key.
2. Press the  key. “IR→100?” will be displayed.
3. Insert vial containing turbidity-free water and press the  key.
4. “WAIT” will be displayed.
5. When the calibration is complete the AQ4500 will proceed to the measure mode.

After successful calibration, the low-turbidity water should read “CAL DONE”.

Refilling the Calibration Standard Vials with Fresh Standard

1. Pour the old standard out of the vial.
2. Wash the vial with laboratory glassware detergent and water. Rinse the vial with turbidity-free water to remove all laboratory detergent from the vial.
3. Rinse the vial with about 5 mL of the standard from the plastic bottle with the matching NTU value.
4. Cap and swirl the vial so the inside of the vial is fully rinsed with the fresh standard.
5. Pour the standard out of the vial.
6. Pour the fresh standard into the vial up to the mark on the vial and cap the vial.
7. Perform the procedure in the **Calibration Check** section with the vial containing the fresh standard.

If the fresh standard does not read with the 10% range of the nominal value, or to the tolerance of your method, follow the steps in one of the **Calibration Mode** sections.

Preparation of Formazin Calibration Standards

Use the following procedure for EPA 180.1, ISO-NEPH, and IR Ratio modes. A primary formazin stock standard at 4000 NTU is available as Cat. No. AC45FZ. This formazin stock standard can be used to prepare primary calibration standards for the EPA 180.1, ISO-NEPH, and IR Ratio modes, as noted in **Table 1**.

For initial calibration, prepare the following primary calibration standards by dilution of the 4000 NTU formazin stock standard with low-turbidity water. Preparing standards at these concentrations yields the best accuracy.

Note: When using the 4000 NTU formazin stock and preparing primary calibration standards, it is important to keep the solutions well mixed when handling.

Note: It is well known that diluted Formazin is unstable. If you choose to use Formazin to calibrate the instrument, ensure that you are using a fresh stock suspension of Formazin to achieve the precision quoted for the instrument. It is very difficult to accurately pipet Formazin for low level NTU standards, due to the non-homogeneous nature of Formazin and because these standards have very limited stability at low levels. Be sure to use good laboratory technique and accurate Class A pipets and refer to ASTM Method 6855-03 for low level standard vial preparation when using Formazin.

Chapter 5 Measurement

Warning: Never pour liquid directly into the sample chamber of the AQ4500. Only use 24 mm diameter vials, Cat. No. AC2T24.

Below are general instructions for performing turbidity measurements. For best results, always cover vial with vial cover whenever measuring a sample.

Turbidity Sample Measurement

1. Allow the sample to come to room temperature.
2. Mix the sample thoroughly to disperse the solids.
3. Wait until all visible air bubbles disappear (a few minutes at most).
4. Select the measurement mode.
5. Pour the sample into a clean, dry turbidity vial. If the sample has settled, mix it gently to resuspend the solids before pouring it into the sample vial.
6. Cap the vial securely.
7. Wipe the vial free of liquid and fingerprints with a soft lint-free wipe or cloth.
8. Place the vial into the AQ4500 sample chamber and cover it with the vial cover.
9. Press the  key.
10. The AQ4500 will display the result. Record the value or log the data. Proceed with the next sample.

Measurement of Low Level Turbidity Samples (< 1 NTU)

Observe the following precautions to improve accuracy of low-level turbidity sample measurements:

1. Prepare the calibration samples with low-turbidity water that has been filtered through a 0.1 mm membrane filter or water that has been demonstrated to be equivalent. Use care to avoid introduction of dust and particulates into the water, calibration standards and samples.
2. Use very clean vials that are free from scratches and imperfections.
3. Index the vials with the low-turbidity water to find the orientation that produces the lowest background blank value. Mark the orientation on the vials, above the marked line (so the orientation mark does not interfere with the meter light path).
4. Apply a light coating of silicon oil to mask minor imperfections in the glass vials. Spread the oil uniformly and remove excess oil by polishing with a soft, lint-free cloth. (Silicone oil and cloth kit, Cat. No. AC45SI)
5. Do not handle vials where the light path of the meter strikes them. Hold vials above the marked line or by the cap, once the cap is on the vial.
6. Use the same indexed vial for the 1 NTU calibration point and for measurement of the low-level turbidity sample or samples. Clean the vial carefully between the calibration and the sample measurement. Fill with low-turbidity water and obtain a blank reading to ascertain that there has been no significant carryover, before using for sample measurements.
7. Rinse the vial a few times with the sample before filling.
8. Degas the sample before measurement, even if no bubbles are visible. Degas by immersing the sample cell in an ultrasonic bath for 1 to 2 seconds only or applying a partial vacuum.

Proceed with measurement steps.

Measurement Tips

- Keep turbidity vials scrupulously clean both inside and out.
- Discard vials if they become scratched or etched and silicone oil does not improve their performance.
- Do not handle vials in the light path area.
- Wash vials well with laboratory detergent, rinse repeatedly with deionized water and allow to air dry.
- If condensation forms on the outside of the vial, warm sample to room temperature, wipe off excess moisture and remix sample before analysis.

EPA Interim Approval Letter



UNITED STATES ENVIRONMENTAL PROTECTION AGENCY
WASHINGTON, D.C. 20460

Gayle Gleichauf
Applications Laboratory Manager
(gayle.gleichauf@thermofisher.com)
Water Analysis Instruments - Orion Products
Thermo Fisher Scientific
166 Cummings Center, Beverly, MA 01915

OFFICE OF
WATER

SUBJECT: Review of Thermo Orion Method AQ 4500, Revision 5 [March 12, 2009] (ATP Case No. N03-0033)

DATE: March 31, 2009

I have reviewed Thermo Orion Method AQ 4500, Revision 5 [March 12, 2009] (ATP Case No. N03-0033), *Determination of Turbidity by Nephelometry*, and the supporting validation data in ATP Case No. N03-0031. I determined that this method meets all requirements for measurement of turbidity in wastewater. That is, the performance of this method is substantially similar to methods listed at 40 CFR Part 136 for measurement of turbidity.

I will recommend that this method be included in future regulatory actions in which EPA periodically adds to the list of approved methods at 40 CFR Part 136.3. However, this ATP review does not replace this notice and comment rulemaking process. In the interim a user may, on a facility-by-facility basis, seek approval from their regional authority for use of this method in Clean Water Act (CWA) programs.

If I can be of any additional assistance on this matter or others, please contact me at walker.lemuel@epa.gov.

Sincerely,

A handwritten signature in blue ink that reads "Lemuel Walker".

Lemuel Walker
CWA ATP Coordinator
Engineering and Analytical Support Branch
Engineering and Analysis Division
Office of Science and Technology

cc: Quality Assurance Managers (all Regions)
ATP Coordinators (all Regions)

Chapter 6 Functions

Log Functions





The AQ4500 turbidimeter allows the user to store up to 100 points in the log.

To Log Data

Once measurement is complete, press the  key to log point prior to next measurement.







To Display Log



1. Press and hold the  key for approximately 3 seconds.
2. “DISPLAY” will be displayed and last point in log will be displayed.
3. Use the  or  key to scroll through log points.
4. Press the  key to escape log display mode.

To Clear Log



1. Go into setup mode by pressing the  key.
2. Press the  or  key; “DEL LOG” will be displayed.
3. Press the  key; “CLR LOG?” will be displayed.
4. Press the  key to abort log clear.
5. Press the  key to clear log. “DELETED” will be displayed and meter will return to measure mode.

Note: It is recommended to print or download log prior to clearing.

To Print or Download Log



1. Plug serial cable, Cat. No. AQ4CBL, into AQ4500.
2. Connect AQ4CBL cable to printer or computer. See the **Setup Menu** section.
3. Go to log display mode and press the  key.

Average Functions



The average “AVG” function enables the meter to take into account larger particles that may be floating through the sample during analysis. This situation is often encountered while testing environmental waters from rivers and lakes. As these particles may not always be present in the measuring path, observing the sample for a longer period of time may yield more accurate and reproducible readings. When AVG is turned on the meter takes a large number of consecutive readings, and then displays the averaged result. The measurement will take slightly longer (approximately 15 seconds). The result is a better or truer reading of the turbidity.

It is important to note that even if the AVG function is off, the meter will perform a certain amount of signal averaging. This smart averaging is most prominent when measuring samples of very low turbidity (<1.5 NTU approximately), and is not noticeable at higher turbidity (above approximately 5 NTU).

To Activate the Average Function

1. Press the  key in measure mode, showing icon on.
2. Press the  key.

To Deactivate the Average Function

1. Press the  key in measure mode, showing icon off.
2. Press the  key.

Chapter 7 Use with Printers and Computers









The AQ4500 allows communication to a printer or communication with a computer. When connecting to a printer or a computer, use Cat. No. AQ4CBL. This cable has a special 3 pin connector on one end for the AQ4500. When used to connect to a computer, a serial adapter may be required (a 25 pin to 9 pin adapter is included with Cat. No. AQ4CBL).

Data Transmission Settings

Baud Rate (Selectable)	1200 (default), 2400, 4800, 9600
Parity	None
Data Bits	8
Start Bit	1
Stop Bit	1

Chapter 8 Customer Services

Turbidimeter Self Test

1. To initiate self test, press the  key.
2. Press the  or  key until display reads “SELFTTEST”.
3. Press the  key to initiate self test.
4. When “PRESS 7” is displayed, press the  key and follow the directions through the test.
5. When complete, unit should display “UNIT OK”.
6. Press any key to confirm display operation.
7. Press any key to exit the self test.
8. Press the  key to return to measurement mode or press the  or  key to proceed through setup menu.

Turbidimeter Maintenance

- Wipe the outside of the turbidimeter with a damp cloth.
- Use a lens tissue, a soft cloth, or clean compressed air can to remove dust and dirt from the sample compartment.

Vial Maintenance

- Always wipe moisture off any vial before inserting into the AQ4500.
- Always wipe fingerprints off any vial before inserting into the AQ4500.
- To clean vials, wash vials well with laboratory detergent, rinse repeatedly with deionized water and allow to air dry.
- Use a light coating of silicone oil (Cat. No. AC45SI) and lint-free cloth to fill in tiny scratches and optimize the vial surface.
- Discard vials if they become scratched or etched and silicone oil does not improve their performance.

Operator Assistance Codes

Operator assistance codes are used to inform a user of a problem during operation. See **Table 3** for these codes. Contact the Technical Support department for assistance.

Warning: Opening the meter enclosure (excluding the battery compartment) will void the warranty.

Table 3
Error Codes

Error Code	Error Code Type
E1	Keyboard error
E2	Bad EPROM error
E4	RTC not detected
E8	RTC not running
E16	RTC not generating interrupts
E32	RTC interrupt pulse out of specification or missing
E64	Bad ADC or battery reading out of specification
E128	White LED, transmission detector or monitor failure
E256	IR LED, transmission detector or monitor failure
E512	Scatter detector reading out of specification
E1024	No signal scatter or transmission readings out of specification
E2048	No signal monitor readings out of specification
E4096	White ZDI scatter too high
E8192	IR DI scatter too high
OVERRNGE	Measurement exceeded operation range

Assistance

After troubleshooting all components of your measurement system, contact Technical Support. Within the United States call 1.800.225.1480 and outside the United States call 978.232.6000 or fax 978.232.6031. In Europe, the Middle East and Africa, contact your local authorized dealer. For the most current contact information, visit www.thermo.com/contactwater.

Warranty

For the most current warranty information, visit www.thermo.com/water.

Declaration of Conformity

Manufacturer: Thermo Fisher Scientific
166 Cummings Center
Beverly, MA 01915 U.S.A.

Hereby declares that the AQ4500 turbidity meter conforms with the following standards and documents:

Safety EC Directive 72/23/EEC Low Voltage Directive

EMC EC 89/336/EEC Electromagnetic Compatibility
EN/IEC 61326:1997 + A1: 1998, Annex C

Emissions EN 55011 (Class A) Emissions
FCC Part 15 Class A
Canadian Emissions (EMCAB-3 ISSUE 2)

Immunity DIN EN 50082-1 1994 Generic Immunity
IEC 61000-4-2 1999 ESD Susceptibility
IEC 61000-4-3 1998 Radiated Immunity

This Thermo Scientific Orion product has been manufactured in compliance with the provisions of the relevant manufacturing and test documents and processes. These documents and processes are recognized as complying with ISO 9001:2008 by QMI, listed as File # 001911.



Patrick Chiu
Senior Quality Engineer,
Regulatory Compliance

Place and Date of Issue:
Beverly, MA
April 16, 2009

Ordering Information

Cat. No.	Description
AQ4500	AQUAfast IV advanced turbidimeter, with field kit, primary standards, silicone oil cloth, standard vials, sample vials and user guide
AC2T24	Turbidity measurement replacement vials, pack of 12
AQ4CBL	AQUAfast IV RS232 cable
AC45ST	AQ4500 calibration kit of primary standards
AC45FZ	4000 NTU formazin standard stock solution, 475 mL
AC45SI	Silicone oil (15 mL) and cloth kit

Specifications

Measurement Method	Range
EPA 180.1	0 to 2000 NTU
EPA GLI Method 2	0 to 40 NTU
ISO-NEPH (7027)	0 to 150 FNU
ISO-ABSB	40 to 4000 FAU
IR-RATIO	0 to 4000 NTU
EBC	0 to 24.5 EBC
ASBC	0 to 236 ASBC
WHITE %T	0 to 100 %T
IR %T	0 to 100 %T
AQ4500 Turbidimeter	
Resolution	0.01 NTU (0 to 9.99) 0.1 NTU (10 to 99.9) 1 NTU (100 to 1000)
Wavelength Selection	Automatic
Repeatability	± 1% of reading or 0.01 NTU
Accuracy	± 2% of reading plus 0.01 NTU (0 to 500 NTU) ± 3% of reading (500 to 1000 NTU) ± 5% of reading (1000 to 2000 NTU)
Source Lamp	Light emitting diode (LED)
Detector	Silicon Photodiode
Sample Size	Approximately 12 mL
Environmental Conditions	
Operating Temperature	- 40.0 to 60.0 °C
Humidity	90% relative humidity at 30.0 °C max
Waterproof	IP67
Inputs	
Keypad	12 dual function keys with tactile feedback
RS232	Yes
Sample Chamber	24 mm
Display	Custom LCD
Units	FNU, NTU, FAU, ASBC, EBC
Low Battery Indicator	Yes

Software Features

Datalogging	100 points
-------------	------------

Built-in Clock with Time and Date Display	Yes
---	-----

Auto Shut-off	Yes
---------------	-----

Electrical Features

Power	4 AA batteries
-------	----------------

Battery Life	2,500 hours (alkaline) 10,000 hours (lithium)
--------------	---

Non-volatile Memory	Yes
---------------------	-----

Appendix A Tungsten vs. LED Discussion

Traditionally, tungsten lamps have been used as light sources in turbidity measuring instrumentation. As such, they have been accepted by US EPA, and widely used in all white light turbidity measuring instrumentation. The primary characteristic, which made their use necessary, is the required broadband spectral distribution. Tungsten bulbs have a measurable output ranging from blue light all the way into infrared wavelengths.

At the time there had been no suitable alternatives to consider, so tungsten bulbs were accepted despite the operating problems they presented. Although LEDs were widely available for a very long time, they were characterized by a relatively narrow spectral emission, unsuitable for US EPA 180.1 method.

Recently, high-powered white LEDs have become available. In essence, these are blue (450 nm) LEDs with a phosphorus coating on the die. This construction gives off a broadband light from deep blue into deep red wavelengths and uses minimal power to accomplish this.

Thermo Scientific Orion products include a meter that uses this new solid-state light source. The Thermo Orion AQ 4500 Method, Revision 5 has been given interim EPA approval for wastewater reporting. The EPA approval was through the ATP (Alternative Test Procedure) program to allow new technologies to be accepted for use where applicable methodologies meet or exceed the original technology. Visit www.thermo.com/waterapps for details. The following are some important considerations which characterize and compare this approach to that of a traditional tungsten light source.

Spectral Distribution

EPA 180.1 method describes a polychromatic measurement system. It is based on a tungsten light source and a detector system with spectral characteristics between 400 and 600 nm.

In order to substitute a white LED light source, it is important to consider the spectral emission and transmission characteristics of the combined electro-optical system.

Detector-LED Combined Responsivity

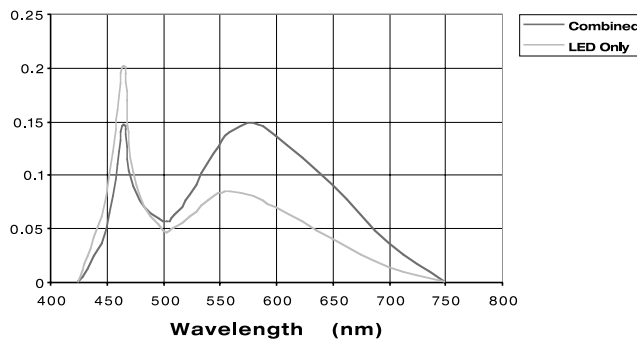

As can be seen from the graph, the white LED – Si photo detector system described here is quite broadband. Its appearance is very similar to that of a tungsten bulb and a cadmium sulfide photo detector combination. It also contains a narrow secondary peak at 460 nm. As the blue output is very limited in tungsten bulbs, this peak can aid in better detection of very small particles. However, as the peak area is very small compared to that of a main body, this enhancement is not very pronounced.

Stability

As follows from the theory of operation, and has been observed in practice, white LED meters exhibit high level of stability over a wide range of operating conditions. The meters have been observed to hold calibration over a period of weeks of intensive use. In contrast, tungsten bulb based instrumentation requires relatively frequent calibrations.

Ambient Light and Electronic Bias Rejection

Unlike tungsten bulbs, LED light sources readily lend themselves to rapidly pulsed operation. This enables the use of synchronous detection, a technique by which the ambient light as well as other electronic induced errors are effectively cancelled out. In doing so it is possible to reduce the ambient light leakage errors when making very low turbidity measurements.

Longevity

LEDs have a very long operating life: typically 100,000 hours or more. Thus, it is not necessary to include provisions for their replacement.

Voltage and Temperature Dependency

It is well known that the spectral output (color temperature) of tungsten bulbs is very dependent on the operating voltage. Although, this voltage can be easily regulated, the meter-to-meter reproducibility for certain samples can vary, as the typical voltage accuracy is on the order of 1%. This has a very significant effect on the color temperature, particularly in view of the fact that the bulbs themselves are not as reproducible as the LED sources.

The operating voltage and ambient temperature have a very minimal effect on LEDs, and are most pronounced on the intensity, not the spectral output. As any minor intensity variations are easily corrected by the meter electronics, for all practical purposes, these errors are non-existent.

Warm-up

As the light sources are powered up, they all experience intensity and spectral characteristic shifts until the operating equilibrium is reached. This is commonly referred as the warm-up time. This parameter is a very important consideration when measuring the turbidity. It is important to have a spectrally and intensity stable light source. Although it is possible to correct for intensity variations, it is not possible to do so for color temperature effects.

Tungsten bulbs suffer from pronounced warm-up problems: both in intensity and color temperature. White LEDs also do have a warm-up period. However, this is much shorter (1 second or so), and the only parameter that significantly varies is the LED intensity.

Aging

Another well-known fact about the tungsten bulbs is that they change their properties through their life (aging). There are number of mechanisms which contribute to this, and presently it is not possible to eliminate these effects. This has number of consequences on the turbidity measurements, the most significant being the need for very frequent calibrations. In contrast, white LEDs do not exhibit any significant aging signs.

Shock Resistance

Unlike tungsten bulbs, all LEDs have very high shock resistance. This is particularly important for field instrumentation.

Bulb Replacement

As mentioned earlier, the LED based instrumentation does not need any provisions for bulb replacement. This not only results in cheaper instrumentation, but since the light source focusing and positioning has been pre-adjusted at the factory, it will be correct for the entire meter operating life.

Water Analysis Instruments



North America

166 Cummings Center
Beverly, MA 01915 USA
Toll Free: 1-800-225-1480
Tel: 1-978-232-6000
Dom. Fax: 1-978-232-6015
Int'l Fax: 978-232-6031

Europe

P.O. Box 254, 3860 AG Nijkerk
Wallerstraat 125K, 3862 CN Nijkerk,
Netherlands
Tel: (31) 033-2463887
Fax: (31) 033-2460832

Asia Pacific

Blk 55, Ayer Rajah Crescent
#04-16/24, Singapore 139949
Tel: 65-6778-6876
Fax: 65-6773-0836

www.thermo.com/water

© 2009 Thermo Fisher Scientific Inc. All rights reserved.

256473-001 Rev. A 06-09

Thermo
SCIENTIFIC