

## Data sheet

## Dygestorium nastołowe DCL-12.00 BB



### Standard equipment for fume hoods:

- entire construction made of galvanized steel without the use of wood-based materials
  - a window made of tempered glass, manually lifted with a counterweight, upwards opening with a blockage at the height of 500 mm. The window has a system preventing the uncontrolled falling of the window
  - energy-saving linear LED light separated from the fume hood's working chamber with a glass - system of a double back wall with exhaust slots in the upper and lower part ensuring the correct extraction of vapors lighter or heavier than air without turbulence and dead zones
  - a safety hatch in the ceiling ensuring decompression in the event of uncontrolled pressure increase in the working chamber
  - a full monitoring set (of Schneider brand) of air flow velocity in the fume hood window compliant with the PE-EN 14175 norm
- CE declaration of conformity: PN-EN 14175; PN-EN 14056; PN-EN 13150

**TECHNICAL DATA - DIMENSIONS**
**overall dims [mm]**

width A	1200
height B	1235
depth C	700

**working space dims (mm)**

width D	1134
window width D1	1054
height E	1000
depth F	430

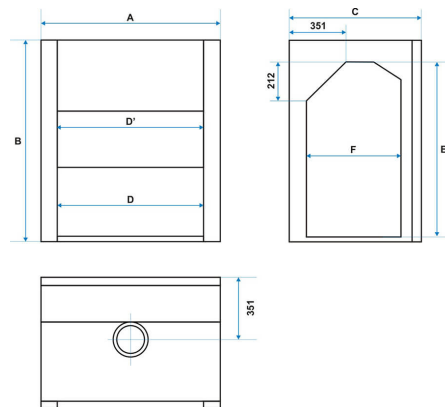
**TECHNICAL DATA**

recommended airflow [m <sup>3</sup> /h]	600 - 950
nominal power [W]	46
voltage**	230 VAC 50Hz
diameter of the air outlet stub [mm]	200
airflow sensor (Schneider FM 550-A-0-E)	compliance with PN-EN 14175-2
electrical insulation	class I
illumination installed outside the working chamber	LED
required capacity of the ventilation system	0,3 - 0,5 [m/s]
standard ventilation system	double rear wall
frame and housing material	The frame is made entirely of galvanized steel. External housing made of galvanized and painted with epoxy paint steel
working chamber wall finishing	galvanized sheet, powder coated with epoxy paint
worktop OPTION (available materials)	- Monolithic ceramics with marine edge - Phenolic resin, epoxy - Stainless steel AISI 304, 316